



4 PORT - 15" PS/2-USB VGA
Single Rail LCD KVM Console Drawer

AL-V504P

Overview

Angustos AL-V504P LCD KVM Console Drawer is optimized for high density Rack in modern Data Center.

Integrating a 15" LED screen, keyboard and mouse pad in a 1U rackmountable sliding housing. The compact design console is utilized for extreme narrow space and super densed area. The AL-V504P can be installed and connected with Angustos KVM Switch or other brand KVM for convenience configuration. The AL-V504P can control up to 04 computers; with 4 additional KVM switches are cascaded, a single AL-V504P LCD KVM Switch can control up to 64 computers.

In addition, the AL-V504P included an additional hot-pluggable USB port that supports other keyboard and mouse for back-up. With all of the technology involved, the AL-V504P LCD KVM Console has gone beyond the expectations and requirements for a modern Data Center use, which including : short space optimization, exceptional display quality, easy to install, extreme versatility.



AL-V504P FRONT VIEW



AL-V504P REAR VIEW

Features

High Density Utilization

- Front USB for back up mouse-keyboard.
- LCD KVM console with an 15" LED-backlit 4:3 LCD monitor in a single rail design.
- Extreme refresh rate up to 75Hz
- Short-depth overall size allowing user to work with in condensed space of high density Rack
- Slide Lock – secure the console drawer to remain firmly in slide position when not in use.

Flexible compatibility

- Superior video quality – up to 1024 x 768 @75Hz; DDC2B; 16.7 M Color.
- Compatible with Angustos and other brands KVM Switches.
- Cascade up to 64 computers from a single console (With compatible KVM Switches)
- Auto PS/2 and USB interface sensing.
- Keyboard and mouse emulation (PS/2 and USB) for seamless switching.
- Operates with all software and operating systems including all Windows versions, DOS, Linux, Unix, BSD, all Sun OS, all Mac OS and NetWare.
- Keyboard Language supports: English (UK), English (US), German (GER.) Japanese, Korean, Russian, Swedish, Chinese.
- Digital & E-Switch key. Mechanical Mute.

Installation Flexibility

- Standard rack mount kit included
- No software required - Plug and Play
- Supports hot-plugging



Saving time



Raise efficiency



Saving Cost



15" 15 Inch display (4:3)



Plug and Play



Password Protected

Compatible Product



AR-V08L

SHORT DEPTH
RACK KVM SWITCH



AR-V16L

SHORT DEPTH
RACK KVM SWITCH



AR-UV32L

HIGH - DENSITY
RACK KVM SWITCH

Angustos

Angustos was founded in 2000 and is now regarded as one of the foremost manufacturers of digital and analogue KVM solutions.

For more than 20 years our customers have been convinced by our core competencies in extending, switching and distributing standardised computer signals.

We are committed to established international standards. We can provide customers with complete Datacenter solutions as well as OEM/ODM services. We can cover even from medium to small business, factory & industrial, military & government, home office & personal use.

KEYBOARD & MOUSE

Keyboard	104 Keys, Digital & E-Switch
	Multiple Languages Option
Compatible	Win/Sun/Unix/Linus/Mac
Mouse	Touchpad
Mouse Resolution	>1000 dots/inch (40x40/mm)
MTBF	1,000,000 Press

KVM SWITCH MODULE

Direct PC connection	04
Maximum PC Connection	64
Port Selection	OSD, Button, Hot Key, IP (Opt)
Console Connector	HDB-15
KVM Connector	HDB-15 Female x 4
Power	DC Jack
Switch button	Panel Digital Keys
Reset Switch	Panel Function Keys
Status LEDs	Nixie Tube (Selected Port)
	Red led (Online Port)
Server Interface	PS/2 , USB
Cascadable	Support

LCD MONITOR

Size / Ratio	15" / 4:3
Video	TFT - LED
Visible Square	409.8 H x 230.4 V
Resolution	1024 x 768 @ 75Hz (Optimal)
	1920 x 1200 @ 60Hz (Max)
Color	16.7 Mil. , True 8 Bit
Contrast	700 : 1 (TyP)
Brightness	250 - 400 nit (Optional)
Pixel Pitch	297 x 297 um
MTBF	100,000 hours

OPERATIONAL SPECIFICATION

Operating Temp	-10°C - 60°C
Storage Temp	-20°C - 70°C
Humidity	0-95%RH, No Condensation

PHYSICAL SPECIFICATION

Housing	Metal
Dimension	528 x 481 x 44 mm
Weight LCD / KVM	12 kg

CONNECTION DIAGRAM

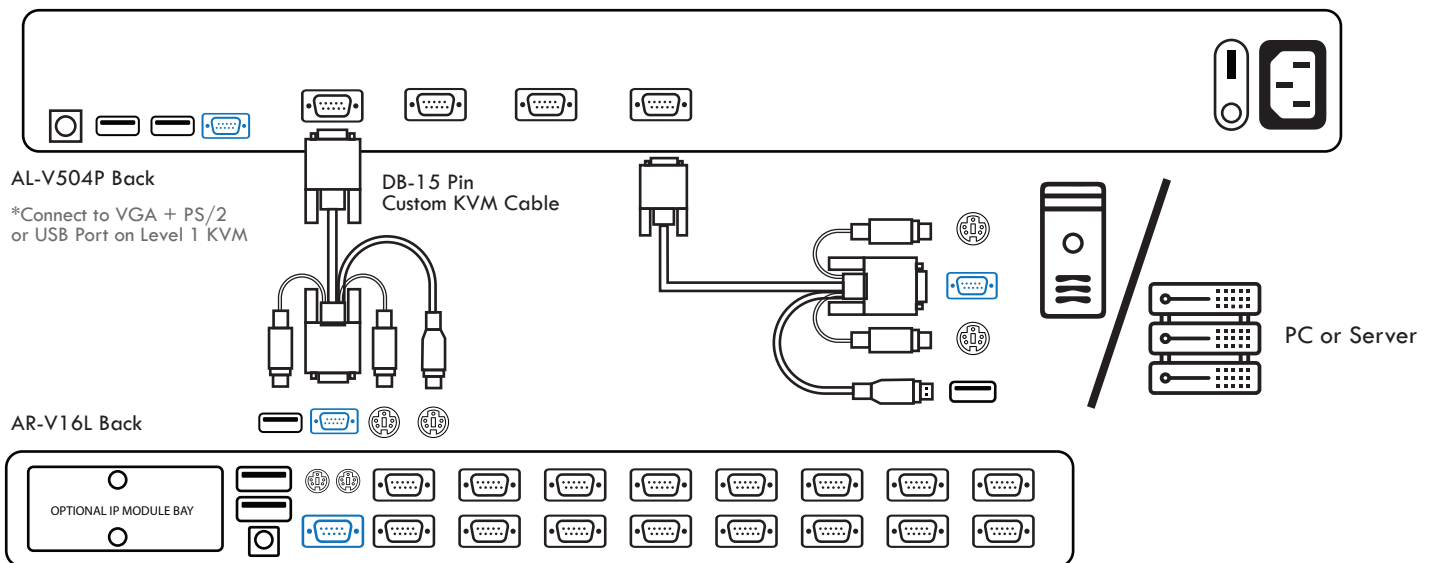

*For connection with IP Module : Use Instruction on Over IP KVM

Cascade KVM